

WARNING

- Battery packs may explode or release toxic materials. Risk of fire or burns. Do not open, crush, modify, disassemble, heat above 140°F (60°C), or incinerate.
- Follow instructions from manufacturer
- Only use Shure charger to recharge Shure rechargeable batteries
- **WARNING:** Danger of explosion if battery incorrectly replaced. Replace only with same or equivalent type.
- Never put batteries in mouth. If swallowed, contact your physician or local poison control center
- Do not short circuit; may cause burns or catch fire
- Do not charge or use battery packs other than Shure rechargeable batteries
- Dispose of battery packs properly. Check with local vendor for proper disposal of used battery packs.
- Batteries (battery pack or batteries installed) shall not be exposed to excessive heat such as sunshine, fire or the like

WARNING: Danger of explosion if incorrect battery replaced. Operate only with AA batteries.

Note: Use only with the included power supply or a Shure-approved equivalent.

Please follow your regional recycling scheme for batteries, packaging, and electronic waste.

WARNING: This product contains a chemical known to the State of California to cause cancer and birth defects or other reproductive harm.

低功率電波輻射性電機管理辦法

第十二條

經型式認證合格之低功率射頻電機，非經許可，公司、商號或使用者均不得擅自變更頻率、加大功率或變更原設計之特性及功能。第十四條

低功率射頻電機之使用不得影響飛航安全及干擾合法通信；經發現有干擾現象時，應立即停用，並改善至無干擾時方得繼續使用。前項合法通信，指依電信法規定作業之無線電通信。低功率射頻電機須忍受合法通信或工業、科學及醫療用電波輻射性電機設備之干擾。

AD1 Axient Digital Bodypack Transmitter

AD series bodypack transmitters deliver impeccable audio quality and RF performance with wide-tuning, High Density (HD) mode, and encryption. The transmitter features durable metal construction, AA or SB900A rechargeable power (with dockable charging), and TA4 or LEMO3 connector options.

Features

Performance

- 20 Hz to 20 kHz range with flat frequency response
- Automatic input staging optimizes gain setting
- AES 256-bit encryption-enabled for secure transmission
- >120 dB dynamic range
- 100 meter (300 feet) line-of-sight operating range
- Selectable modulation modes optimize performance for spectral efficiency
 - Standard – optimal coverage, low latency
 - High density – dramatic increase in max system channel count

- Built-in tone generator and RF markers to facilitate walk-testing
- Switchable Power Levels = 2/10/35 mW (region dependent)
- Frequency Diversity selection using two bodypacks

Design

- TA4 or LEMO3 audio connector option
- Backlit LCD with easy to navigate menu and controls
- Rugged metal construction
- Flexible ¼ wave antenna
- Menu and power lockout

Power

- Over 8 hours continuous use with 2 x AA alkaline batteries
- Shure SB900A lithium-ion rechargeable battery provides extended battery life, precision metering, and zero memory effect
- External charging contacts for docked charging

Included Components

AA alkaline batteries (2)	80B8201
¼ wave antenna	Varies by Region
Threaded TAF4 adapter	WA340
Transmitter carrying case	WA610
Zipper bag	26A13
Belt clip	44A12547

Optional Accessories

Bodypack rechargeable lithium-ion battery	SB900A
Y-Cable for bodypack transmitters	AXT652
LEMO Y-cable for bodypack transmitters	AXT652LEMO3
Instrument cable	WA302

Replacement belt clip	44A12547
Instrument cable with right angle 1/4" connector	WA304
Mute Switch for Bodypack	WA661
Mute Switch for 2 Bodypacks	WA662

AD1 Transmitter Overview

① RF Antenna

For RF signal transmission.

② Display

View menu screens and settings. Press any control button to activate the backlight.

③ Infrared (IR) Port

Align with the receiver IR port during an IR Sync for automated transmitter tuning and setup.

④ Control Buttons

Use to navigate through parameter menus and to change settings.

⑤ Battery Compartment

Requires two AA batteries or Shure SB900A rechargeable battery.

⑥ AA Battery Adapter

Use to secure AA batteries. Remove when using a Shure SB900A battery.

⑦ SMA Connector

Connection point for RF antenna.

⑧ Power Switch

Powers the unit on or off.

⑨ Power LED

- Green = unit is powered on
- Red = low battery, Mute Mode enabled, input overload, or battery error (see Troubleshooting)
- Amber = power switch mode: locked with switch in off position

⑩ Input Jack

Connects to a 4-Pin Mini Connector (TA4F) microphone or instrument cable. Note: A LEMO connector model variation of this transmitter is available.

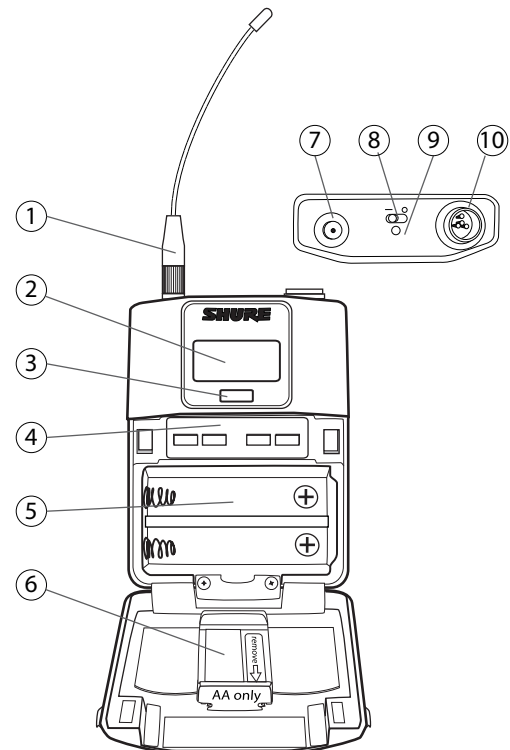

Updating Firmware

Firmware is embedded software in each component that controls functionality. Periodically, new versions of firmware are developed to incorporate additional features and enhancements. To take advantage of design improvements, new versions of the firmware can be uploaded and installed using the Shure Update Utility. The Shure Update Utility is available for download from <http://www.shure.com/>.

Firmware Versioning

When performing an update, download firmware to the receiver first, and then update transmitters to the same firmware version to ensure consistent operation.

The firmware numbering for Shure devices uses the following format: MAJOR.MINOR.PATCH (e.g., 1.2.14). At a minimum, all devices on the network (including transmitters), must have the same MAJOR and MINOR firmware version numbers (e.g., 1.2.x).

Updating the Transmitter

1. To upload the firmware to the transmitter, go to Device Configuration>Tx Firmware Update on the receiver.
2. Place the transmitter on its side and align the IR ports.
3. Press ENTER on the receiver to begin the download to the transmitter. IR ports must be aligned for the entire download, which can take 50 seconds or longer.

Transmitter Controls

Use the controls to navigate through parameter menus and change values.

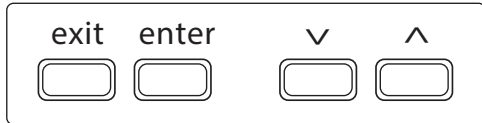

exit	Acts as a 'back' button to return to previous menus or parameters without confirming a value change
enter	Enters menu screens and confirms parameter changes
∨∧	Use to scroll through menu screens and to change parameter values

Tip: Use the following control shortcuts for quick set up:

- Hold the ∧ button while powering-on to lock or unlock the transmitter controls
- Hold the exit button while powering-on to set the transmitter RF output to mute

Locking the Controls

Lock transmitter controls to prevent accidental or unauthorized changes to parameters. The lock icon is shown on the home screen when the control lock is enabled.

1. From the Utilities menu, navigate to Lock and select one of the following:
 - Locked: Locks the controls
 - Unlocked: Unlocks the controls
2. Press enter to save.

Tip: To quickly unlock a transmitter: Press enter, select Unlocked, and press enter.

Home Screen Display

The home screen shows transmitter information and status.

Tip: There are four options to choose the information shown on the home screen. Use the arrow buttons to select one of the following choices:

- Name
- Frequency Setting
- Group (G) and Channel (C)
- Device ID

The following icons appear to indicate transmitter settings:

- Battery runtime in hours and minutes or bar display
- Key: Displayed when encryption is enabled

- Lock: Displayed when controls are locked
- STD: Standard Transmission Mode
- HD: High Density Transmission Mode
- Box: When the box has an "x", Mute Mode is on and engaged. If the box is empty, Mute Mode is on, but not engaged.

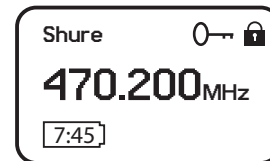

Battery Installation

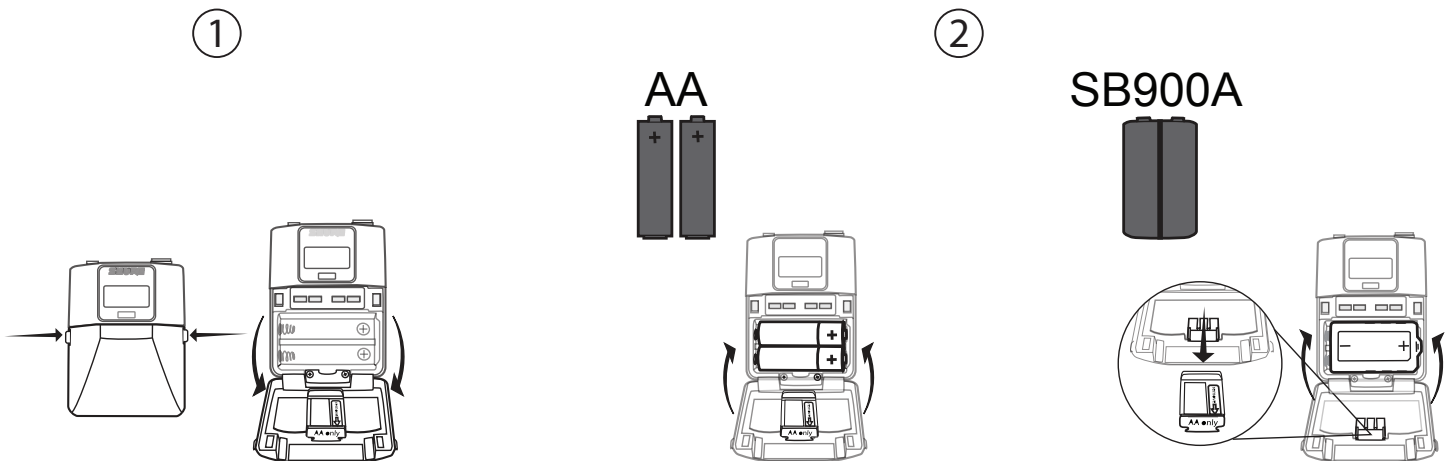

① Accessing the Battery Compartment

Press the side tabs on the bodypack and open the battery door as shown to access the battery compartment.

② **Installing Batteries**

- **AA Batteries:** Place batteries (note polarity markings) and AA Adaptor as shown and close the door
- **Shure SB900A Battery:** Place battery as shown (note polarity markings). Remove the AA adaptor and set it aside. Close the door to secure the battery.

Note: If using AA batteries, set the battery type using the transmitter menu.

Setting the AA Battery Type

To ensure accurate display of transmitter runtime, set the battery type in the transmitter menu to match the installed AA battery type.

Note: If a Shure SB900A rechargeable battery is installed, selecting a battery type is not necessary and the battery type will display Shure.

1. Navigate to the Utilities and select Battery.
2. Use the ▼▲ buttons to select the installed battery type:
 - Alkaline = Alkaline
 - NiMH = Nickel Metal Hydride
 - Lithium = Lithium Primary
3. Press enter to save.

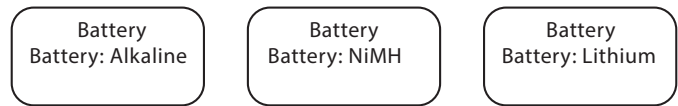

AA Battery Installation

Fully insert the batteries as shown to ensure proper battery contact and to allow the door to latch securely.

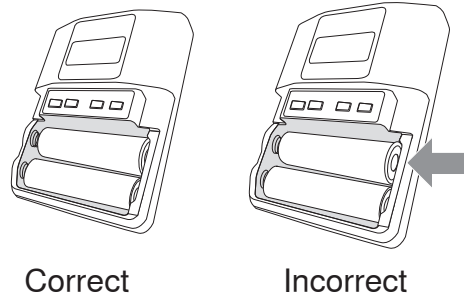

Shure SB900A Rechargeable Battery

Shure SB900A lithium-ion batteries offer a rechargeable option for powering the transmitters. Batteries quickly charge to 50% capacity in one hour and reach full charge within three hours.

Single chargers and multiple bay chargers are available to recharge the Shure batteries.

Caution: Only charge Shure rechargeable batteries with a Shure battery charger.

- Bars: Indicates the number of bars displayed
- Time: Battery runtime
- Charge: Percentage of charge capacity
- Health: Percentage of current battery health
- Cycle: Record of the number of charging cycles for the installed battery
- Temp: Battery temperature in Fahrenheit and Celsius

Shure SB900A Runtime

2 mW	10 mW	35 mW
Up to 9 hours	Up to 9 hours	Up to 5 hours

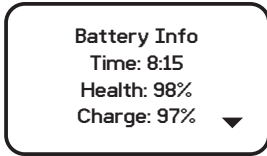

Checking Battery Info

When using an SB900A rechargeable battery, the receiver and transmitter home screens display the number of hours and minutes remaining.

Detailed information for the battery is displayed Battery menu of the transmitter: Utilities>Battery

- Battery: The chemistry type of for the installed battery (Shure, Alkaline, Lithium, NiMH)

Important Tips for Care and Storage of Shure Rechargeable Batteries

Proper care and storage of Shure batteries results in reliable performance and ensures a long lifetime.

- Always store batteries and transmitters at room temperature

- Ideally, batteries should be charged to approximately 40% of capacity for long-term storage
- Periodically clean the battery contacts with alcohol to maintain ideal contact
- During storage, check batteries every 6 months and recharge to 40% of capacity as needed

For additional rechargeable battery information, visit www.shure.com.

AA Batteries and Transmitter Runtime

Transmitters are compatible with the following AA battery types:

- Alkaline
- Nickel Metal Hydride (NiMH)
- Lithium Primary

A 5-segment battery indicator representing the charge level of the transmitter battery is displayed on the screens of the transmitter and receiver. The following tables contain the approximate remaining transmitter runtime in hours:minutes.

Note: Battery runtimes vary by manufacturer, battery age, and environmental conditions.

AA Batteries and Transmitter Runtime

Alkaline

Battery Indicator	Approximate Runtime Remaining (hours:minutes)
	8:00 - 6:00
	> 4:00
	> 1:45
	≅ 1:45
	≅ 0:45
	≅ 0:15

NiMH (2700 mAh)

Battery Indicator	Approximate Runtime Remaining (hours:minutes)
	11:00 - 8:00
	> 5:00
	> 2:00
	≅ 2:00
	≅ 0:45
	≅ 0:15

Lithium Primary (3500 mAh)

Battery Indicator	Approximate Runtime Remaining (hours:minutes)
	14:00 - 10:00
	> 6:00
	> 2:00
	≅ 2:00
	≅ 0:45
	≅ 0:15

Menu Parameters

The Main menu organizes the available transmitter parameters into three sub-menus:

- Radio
- Audio
- Utilities

Tip: Use the arrow buttons to scroll between the sub-menus.

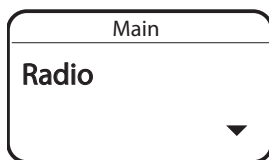

- A menu parameter will blink when editing is enabled
- To increase, decrease or change a parameter, use the arrow buttons
- To save a menu change, press enter
- To exit a menu without saving a change, press exit

Tips for Editing Menu Parameters

- To access the menu options from the home screen, press the enter button. Use the arrow buttons to access additional menus and parameters.

Menu Map

Radio

- Group Channel
- Frequency
- RF Power
- RF Output

Audio

- Pad
- Offset
- Polarity
- MuteMode
- Tone
- Level

Utilities

- Dev ID
- Lock
- Marker
- Battery
- About
- Reset All

Radio Menu

G: and C: Group and Channel

Press the enter button to enable editing of a group (G:) or channel (C:). Use the arrow buttons to adjust the values.

Frequency

Press the enter button once to edit the first 3 digits, or twice to edit the second 3 digits.

RF Power

Higher power settings can extend the range of the transmitter.

RF Output

- On: RF signal is active
- Mute: RF signal is inactive

Audio Menu

Pad

Adjust the pad to avoid overloading the audio input. Select -12 dB or Off.

Offset

Adjust Offset level to balance mic levels when using two transmitters for frequency diversity or when assigning multiple transmitters to receiver slots. Adjustment range: -12 dB to +21 dB.

Polarity

Selectable polarity assignment for LEMO connector transmitters:

- Pos: Positive pressure on microphone diaphragm produces positive voltage on pin 2 (with respect to pin 3 of XLR output) and the tip of the TRS output.
- Neg: Positive pressure on microphone diaphragm produces negative voltage on pin 2 (with respect to pin 3 of XLR output) and the tip of the TRS output.

MuteMode

When enabled, the power switch is configured as a mute switch for the audio:

- Power switch on: audio signal on
- Power switch off: audio signal muted

Tone

Transmitter will generate a continuous test tone. The tone can be set to 400 Hz or 1000 Hz.

Level

When enabled, allows for adjustment of the output level of the test tone.

Utilities Menu

Dev ID

Assign a device ID of up to 9 letters or numbers.

Lock

Locks the transmitter controls and power switch.

Marker

When enabled, press the enter button to drop a marker in Wireless Workbench.

Battery

Displays battery information:

- Battery: The chemistry type of for the installed battery (Shure Rechargeable, Alkaline, Lithium, NiMH)
- Bars: Indicates the number of bars displayed
- Time: Battery runtime
- Charge: Percentage of charge capacity
- Health: Percentage of current battery health
- Cycle: Record of the number of charging cycles for the installed battery
- Temp: Battery temperature in Fahrenheit and Celsius

About

Displays transmitter information:

- FW: Installed firmware
- HW: Hardware version
- SN: Serial number

Reset All

Restores all transmitter parameters to factory settings.

IR Sync

Use IR Sync to form an audio channel between the transmitter and receiver.

Note: The receiver band must match the band of the transmitter.

1. Select a receiver channel.

2. Tune the channel to an available frequency using group scan or manually turn to an open frequency.
3. Power on the transmitter.
4. Press the SYNC button on the receiver.
5. Align the IR windows between the transmitter and the receiver so that the IR LED illuminates red. When complete, Sync Success! appears. The transmitter and receiver are now tuned to the same frequency.

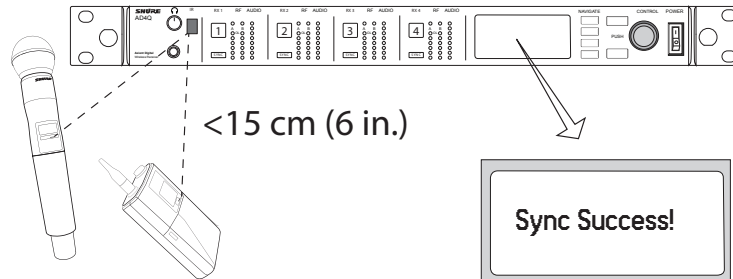

Note:

Any change to the encryption status on the receiver (enabling/disabling encryption) requires a sync to send the settings to the transmitter. New encryption keys for the transmitter and receiver channel are generated on every IR sync, so to request a new key for a transmitter, perform an IR sync with the desired receiver channel.

Setting the Frequency Manually

The transmitter can be manually tuned to a specific frequency, group, or channel

1. Navigate to the Radio menu.
2. To manually select a frequency, scroll to G: and C: to edit the group and channel, or to the frequency parameter .
3. Press enter to enable editing.
4. Use the \wedge \vee buttons to adjust the group, channel, or frequency.
5. Press enter to save, and then press exit when finished.

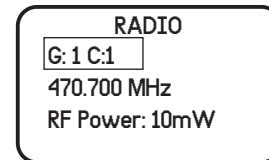

Wearing the Bodypack Transmitter

Clip the transmitter to a belt or slide a guitar strap through the transmitter clip as shown.

For best results, the belt should be pressed against the base of the clip.

Tip: The clip can be removed and rotated 180 degrees to increase mounting options.

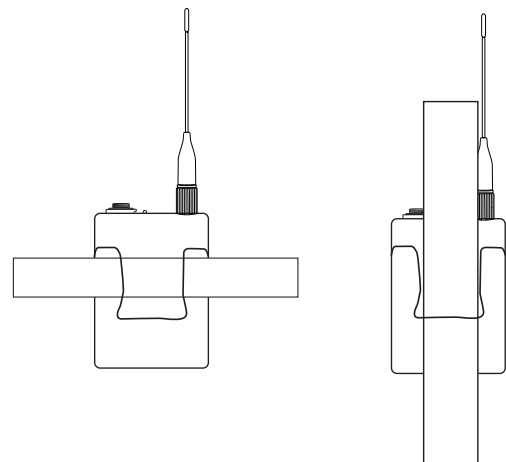

RF Mute

RF Mute prevents transmission of the audio by suppressing the RF signal, while allowing the transmitter to remain powered-on. The home screen displays RF Mute in this mode.

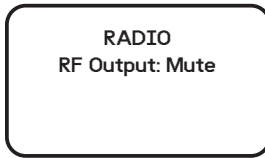

1. From the Radio menu, navigate to RF Output.
2. Choose one of the following options:
 - On: RF signal is active
 - Mute: RF signal is disabled
3. Press enter to save.

Turning the transmitter off and on, or replacing the battery will restore RF Output to On.

Power-on RF Mute

Power-on RF Mute places the transmitter in RF Mute mode immediately when turned on.

- Starting with the transmitter off, press and hold the exit button, and then switch on the power
- Continue to hold the exit button until the RF Muted message appears on the home screen

Input Overload

The OVERLOAD message is displayed when the audio input experiences a high-level signal. The power LED will turn red as an additional indicator of an overload. Reduce the input signal or enable the input pad to remove the overload.

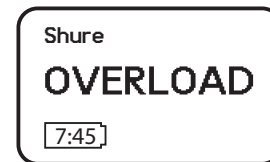

Matching Audio Levels with Offset

When linking two or more transmitters to a receiver, there may be a difference in volume levels between microphones or instruments. If this occurs, use the Offset function to match the audio levels and eliminate audible volume differences between transmitters. If using a single transmitter, set Offset to 0 dB.

1. Turn on the first transmitter and perform a sound check to test the audio level. Turn off the transmitter when finished.
2. Turn on the second transmitter and perform a sound check to test the audio level. Repeat for any additional transmitters.

3. If there is an audible difference in the sound level between the transmitters, navigate to the Offset menu (Audio>Offset) in the transmitter to increase or decrease the Offset in realtime to match the audio levels.

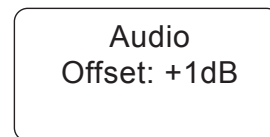

Tone Generator

The transmitter contains an internal tone generator that produces a continuous audio signal. The tone is helpful when conducting a sound check or for troubleshooting the audio signal chain. The level of the tone is adjustable from -60 dB to 0 dB and the frequency can be set to 400 Hz or 1000 Hz.

1. From the Audio menu select Tone.
2. Set the frequency to 400 Hz or 1000 Hz.
3. Select Level and use the arrow buttons adjust the value between -60 dB and 0 dB.

Turn off the tone by selecting Off from the menu or by cycling the transmitter power.

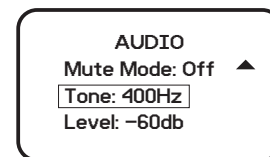

Tip: Always start with the level set to -60 dB to avoid overloading speakers or headphones.

Specifications

Mic Offset Range

-12 to 21 dB (in 1 dB steps)

Battery Type

Shure SB900A Rechargeable Li-Ion or LR6 AA batteries 1.5 V

Battery Runtime

@ 10 mW

Shure SB900A	up to 9 hours
alkaline	up to 8 hours

0

Dimensions

86 mm x 66 mm x 23 mm (3.4 in. x 2.6 in. x 0.9 in.) H x W x D

Weight

155 g (5.0 oz.), without batteries

Housing

Cast Metal

Audio Input**Connector**

4-Pin male mini connector (TA4M) or Lemo Connector

Configuration

Unbalanced

Impedance1 M Ω ,**Maximum Input Level**

1 kHz at 1% THD

Pad Off	8.5 dBV (7.5 Vpp)
Pad On	20.5 dBV (30 Vpp)

Preamplifier Equivalent Input Noise (EIN)System Gain Setting \geq +20

-120 dBV, A-weighted, typical

RF Output**Connector**

SMA

Antenna Type

1/4 wave

Impedance50 Ω **Occupied Bandwidth**

<200 kHz

Modulation Type

Shure Axient Digital Proprietary

0 See Battery Runtime Chart

Power

2 mW, 10 mW, 35 mW

1

Frequency Bands and Transmitter RF Power

Band	Frequency Range (MHz)	RF Power (mW) ^{***}
G53	470 to 510	2/10/35
G54	479 to 565	2/10/20
G55	470 to 636*	2/10/35
G56	470 to 636	2/10/35
G57	470 to 616*	2/10/35
G62	510 to 530	2/10/35
H54	520 to 636	2/10/35
K53	606 to 698*	2/10/35
K54	606 to 663**	2/10/35
K55	606 to 694	2/10/35
K56	606 to 714	2/10/35
K57	606 to 790	2/10/35
K58	622 to 698	2/10/35
L54	630 to 787	2/10/35
R52	794 to 806	2/10/35
JB	806 to 810	2/10
X51	925 to 937.5	2/10
X55	941 to 960	2/10/35

Note: *with a gap between 608 to 614 MHz.

Note: **with a gap between 608 to 614 MHz and a gap between 616 to 653 MHz.

Note: ***power delivered to the antenna port.

Country Code Code de Pays Codice di paese Código de país Länder-Kürzel	Frequency Range Gamme de frequences Gamme di frequenza Gama de frecuencias Frequenzbereich
A, B, BG, CH, CY, CZ, D, DK, EST, F	*
FIN, GB, GR, H, HR, I, IRL, IS, L, LT	*
M, N, NL, P, PL, RO, S, SK, SLO, TR	*
all other countries	*

* This equipment may be capable of operating on some frequencies not authorized in your region. See Licensing Information.

1 See Frequency Range and Output Power table, varies by region

Country Code	Frequency Range
Code de Pays	Gamme de frequences
Codice di paese	Gamme di frequenza
Código de país	Gama de frecuencias
Länder-Kürzel	Frequenzbereich
A, B, BG, CH, CY, CZ, D, DK, EST, F	*
FIN, GB, GR, H, HR, I, IRL, IS, L, LT	*
M, N, NL, P, PL, RO, S, SK, SLO, TR	*
all other countries	*

* This equipment may be capable of operating on some frequencies not authorized in your region. See Licensing Information.

Country Code	Frequency Range
Code de Pays	Gamme de frequences
Codice di paese	Gamme di frequenza
Código de país	Gama de frecuencias
Länder-Kürzel	Frequenzbereich
A, B, BG, CH, CY, CZ, D, DK, EST, F	*
FIN, GB, GR, H, HR, I, IRL, IS, L, LT	*
M, N, NL, P, PL, RO, S, SK, SLO, TR	*
all other countries	*

* This equipment may be capable of operating on some frequencies not authorized in your region. See Licensing Information.

Input Connector Diagrams

TA4M

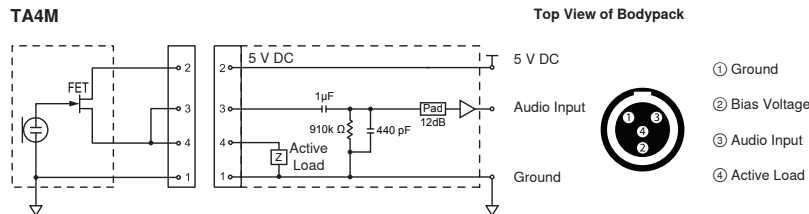

LEMO

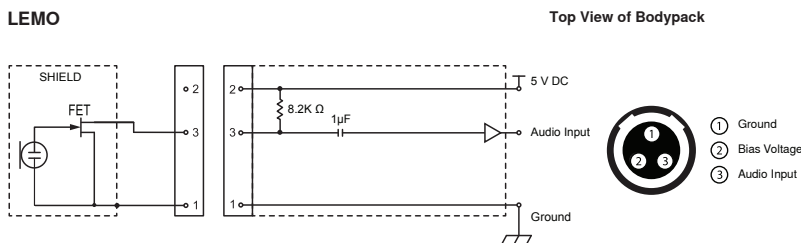

Certifications

Certified under FCC Part 74.

Certified in Canada to RSS-210.

FCC ID: DD4AD1G55, DD4AD1G57, DD4AD1K53, DD4AD1K54, DD4AD1X55. **IC:** 616A-AD1G55, 616A-AD1K53.

This device complies with Industry Canada licence-exempt RSS standard(s). Operation of this device is subject to the following two conditions: (1) this

device may not cause interference, and (2) this device must accept any interference, including interference that may cause undesired operation of the device. Le présent appareil est conforme aux CNR d'Industrie Canada applicables aux appareils radio exempts de licence. L'exploitation est autorisée aux deux conditions suivantes : (1) l'appareil ne doit pas produire de brouillage, et (2) l'utilisateur de l'appareil doit accepter tout brouillage radioélectrique subi, même si le brouillage est susceptible d'en compromettre le fonctionnement.

Meets essential requirements of the following European Directives:

- WEEE Directive 2002/96/EC, as amended by 2008/34/EC
- RoHS Directive 2011/65/EU

Note: Please follow your regional recycling scheme for batteries and electronic waste

This product meets the Essential Requirements of all relevant European directives and is eligible for CE marking.

Hereby, Shure Incorporated declares that the radio equipment is in compliance with Directive 2014/53/EU. The full text of the EU declaration of conformity is available at the following internet address: <http://www.shure.com/europe/compliance>

Authorized European representative:
Shure Europe GmbH
Headquarters Europe, Middle East & Africa
Department: EMEA Approval
Jakob-Dieffenbacher-Str. 12
75031 Eppingen, Germany
Phone: +49-7262-92 49 0
Fax: +49-7262-92 49 11 4
Email: EMEAsupport@shure.de

LICENSING INFORMATION

Licensing: A ministerial license to operate this equipment may be required in certain areas. Consult your national authority for possible requirements.

This device complies with Industry Canada licence-exempt RSS standard(s). Operation of this device is subject to the following two conditions: (1) this device may not cause interference, and (2) this device must accept any interference, including interference that may cause undesired operation of the device.

Le présent appareil est conforme aux CNR d'Industrie Canada applicables aux appareils radio exempts de licence. L'exploitation est autorisée aux deux conditions suivantes : (1) l'appareil ne doit pas produire de brouillage, et (2) l'utilisateur de l'appareil doit accepter tout brouillage radioélectrique subi, même si le brouillage est susceptible d'en compromettre le fonctionnement.

Changes or modifications not expressly approved by Shure Incorporated could void your authority to operate the equipment. Licensing of Shure wireless microphone equipment is the user's responsibility, and licensability depends on the user's classification and application, and on the selected frequency. Shure strongly urges the user to contact the appropriate telecommunications authority concerning proper licensing, and before choosing and ordering frequencies.

Information to the user

This equipment has been tested and found to comply with the limits for a Class B digital device, pursuant to Part 15 of the FCC Rules. These limits are designed to provide reasonable protection against harmful interference in a residential installation. This equipment generates uses and can radiate radio frequency energy and, if not installed and used in accordance with the instructions, may cause harmful interference to radio communications. However, there is no guarantee that interference will not occur in a particular installation. If this equipment does cause harmful interference to radio or television reception, which can be determined by turning the equipment off and on, the user is encouraged to try to correct the interference by one or more of the following measures:

- Reorient or relocate the receiving antenna.
- Increase the separation between the equipment and the receiver.
- Connect the equipment to an outlet on a circuit different from that to which the receiver is connected.
- Consult the dealer or an experienced radio/TV technician for help.

Australia Warning for Wireless

This device operates under an ACMA class licence and must comply with all the conditions of that licence including operating frequencies. Before 31 December 2014, this device will comply if it is operated in the 520-820 MHz frequency band. **WARNING:** After 31 December 2014, in order to comply, this device must not be operated in the 694-820 MHz band.